

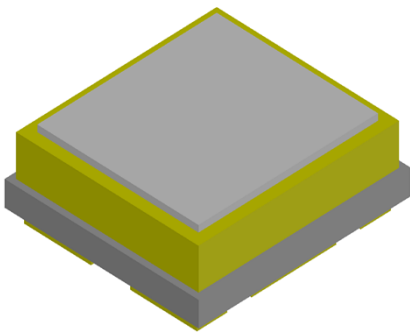

OC-VC series

Product Specification

Product	3532 VCSEL Emitter
Part Number	OCVC32-7258V9420-V0
Issue Date	2019/10/14



INTERNAL USE ONLY

■ Features

- Vertical - Cavity Surface - Emitting Laser technology
- Package size = 3.5mm x 3.2mm x 1.3mm
- Pulse Output power 2W emitter
- Peak wavelength $\lambda_p = 940\text{nm}$
- Divergence angles = $72^\circ \times 58^\circ$
- Wavelength stabilized (0.07nm per $^\circ\text{C}$)
- Narrow spectral width (<1nm)
- RoHS
- Photo Diode inside

■ Applications

- 3D depth sensing
- Gesture sensing
- Flood illuminator



Product Nomenclature

The product name is designated as below:

OCVCAB – CDEFGHIJK

Designation:

OCVC = Orient-Chip Technology Co.,LTD VCSEL Series Product.

AB = Package size ⁽¹⁾

CDEF = Divergence Angle ⁽²⁾

G = Internal Code

HI = Wavelength ⁽³⁾

JK = Pulse mode Output Power ⁽⁴⁾

Notes

1. Package Size:

Symbol	Description
32	3.5mm x 3.2mm

2. Divergence Angle:

Symbol	Description
5040	50° x 40°
6045	60° x 45°
7258	72° x 58°
9070	90° x 70°
1190	110° x 90°

3. Wavelength:

Symbol	Description
85	850nm
94	940nm

4. Pulse mode Output Power:

Symbol	Description
05	0.5W
10	1W
20	2W
30	3W
40	4W



■ **Maximum Ratings (Ta = 25 °C)**

Parameter	Symbol	Values	Unit
Operating temperature range	T _{op}	-20 ~ 85	°C
Storage temperature range	T _{stg}	-40 ~ 85	°C
Maximum package SMT solder Reflow temperature		260°C 10seconds	°C

■ **Characteristics(Ta = 25 °C)**

Parameter	Symbol	Condition	Min.	Typ.	Max.	Unit
Pulse Output power	P _o	I _F = 3.0 A	1700	2100	-	mW
Wavelength	λ _p	I _F = 3.0 A	930	940	950	nm
Forward Voltage	V _f	I _F = 3.0 A	1.7	2.0	2.3	V
Threshold current	I _{th}		-	500	-	mA
Power Conversion Efficiency	PCE	I _F = 3.0 A	-	35	-	%
Wave Shift	Δλ/ΔT	I _F = 3.0 A	-	0.07	-	nm/°C
Slope Efficiency			-	0.84	-	W/A

Note:

- Forward Voltage tolerance is ±0.1 V, Radiant Intensity tolerance is ±10%
Others measurement allowance is ±10%.
- VCSEL is mounted on PCB and measured with operating bias current @ 3A,10ms
- Due to the special conditions of the manufacturing processes of VCSEL, the typical data of technical parameters can only reflect statistical figures. These do not necessarily correspond to the actual parameters of each single product, which could differ from the typical data or the typical characteristic line. If requested, e.g. because of technical improvements, these typ. data will be changed without any further notice.

■ **Photodiode Electrical / Optical Characteristics(Ta = 25 °C)**

Parameter	Symbol	Condition	Min.	Typ.	Max.	Unit
Forward Voltage	V _f	I _F = 10 mA	0.5		1.3	V
Reverse Breakdown Voltage	V _{BR}	I _R = 100 uA	35			V
Reverse Dark Current	I _D	V _R = 10 V		2	10	nA
Light Current	I _L	V _R = 5 V		0.5		uA
Peak Sensing Wavelength	λ _p	--		940		nm



■ **Radiometric Power Bin Structure at 3000mA**

Color	Bin Code	Minimum Radiometric Power (mW)	Typical Radiometric Power (mW)
Infrared 940	B2	1700	2100

- OCS maintains a tolerance of $\pm 10\%$ on flux and power measurements.
- The flux bin of the product may be modified for improvement without notice.

■ **Peak Wavelength Bin Structure at 3000mA**

Color	Bin Code	Centroid Wavelength
Infrared 940	94	940

■ **Forward Voltage Bin Structure at 3000mA**

Color	Bin Code	Typical Voltage (V)	Maximum Voltage (V)
Infrared 940	A1	2.0	2.3

- OCS maintain a tolerance of $\pm 0.1V$ for Voltage measurements.



■ Divergence angles corresponds to the direction

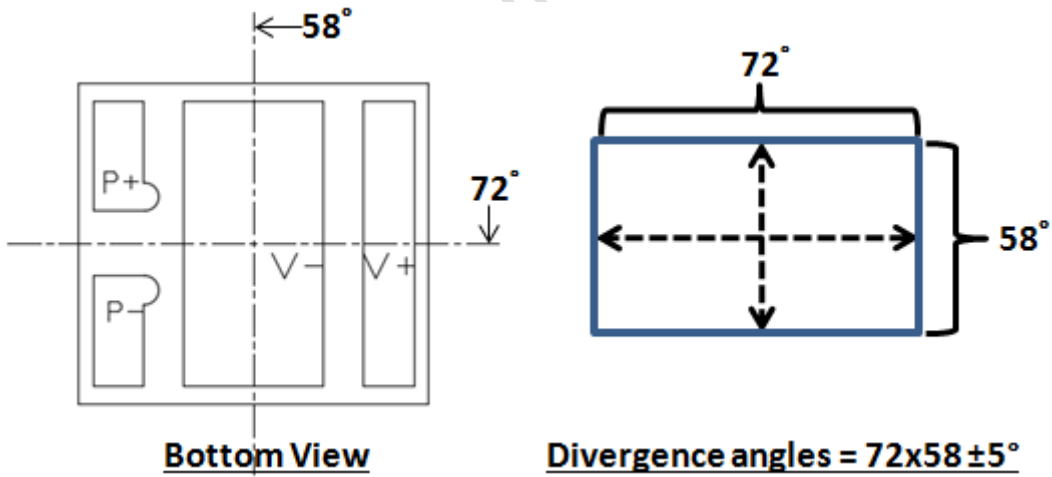
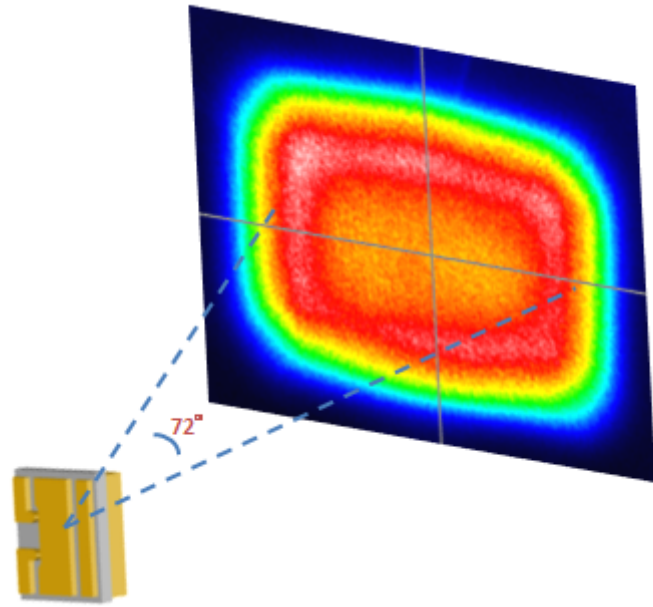



■ Pulse Output Power vs. Forward Current

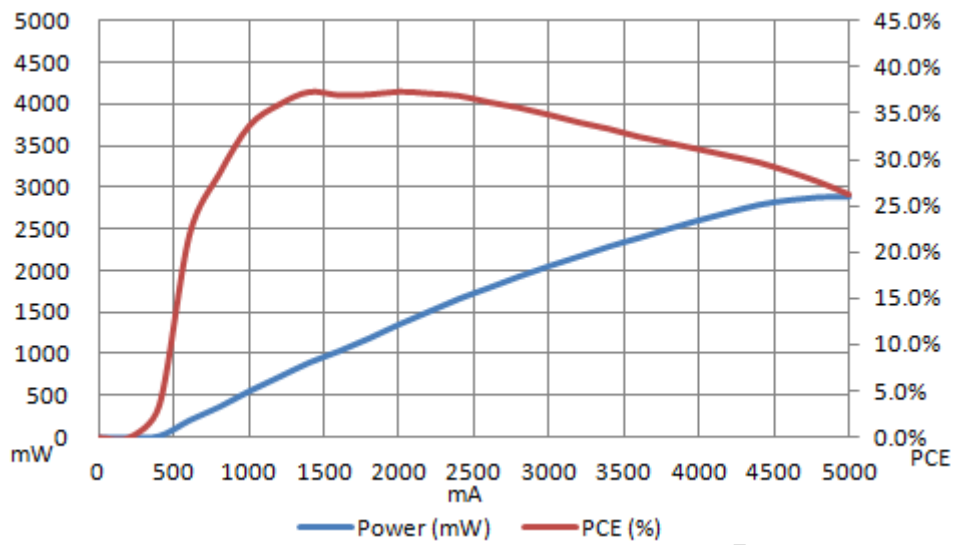

■ Forward Voltage vs. Forward Current

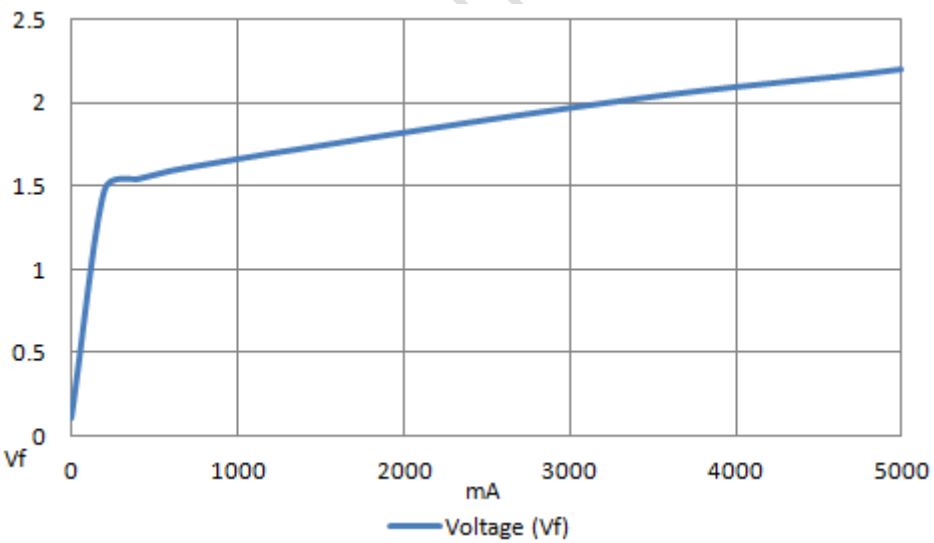



■ Outline Dimension

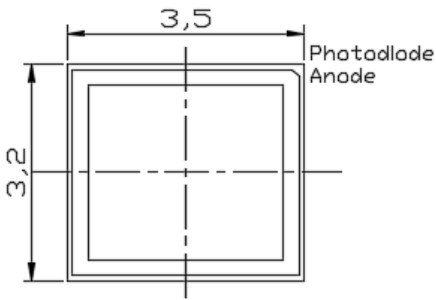

Top View

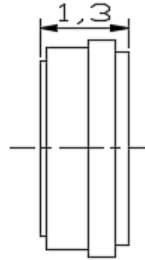

Side View

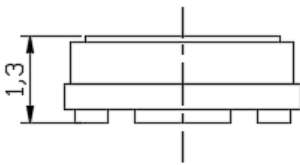

Side View



Polarity

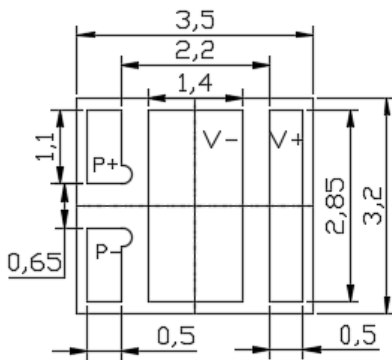
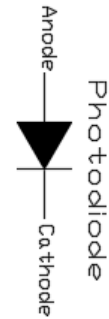

P: Photodiode
V: VCSEL

Bottom View

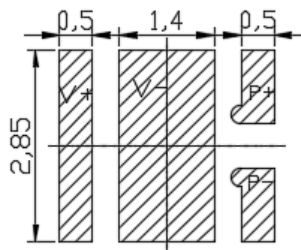

Recommended Solder Pad

Unit: mm

Tolerance: ± 0.1 mm



■ Cleaning

1. If washing is required, recommend to use alcohol as a solvent.
2. Recommend to avoid cleaning the VCSEL by ultrasonic. If necessary, pre-test the VCSEL is necessary to confirm whether any damage occur after the process.

■ Precautions for use

1. Over-current-proof

- 1.1 Customer must apply resistors for protection; otherwise slight voltage shift will cause big current change (Burn out will happen).

2. Storage

- 2.1 Do not open moisture proof bag before the products are ready to use.
- 2.2 Before opening the package: The VCSEL should be kept at 30°C or less and 90%RH or less.
- 2.3 After opening the package: The VCSEL floor life is 1 year under 30°C or less and 60% RH or less. If unused VCSEL remain, it should be stored in moisture proof packages.
- 2.4 If the moisture absorbent material (silica gel) has faded away or the VCSEL have exceeded the storage time, baking treatment should be performed using the following conditions. Baking treatment: 60±5°C for 24 hours.

3. Handling indications

- 3.1 During processing, mechanical stress on the surface should be minimized as much as possible. Sharp objects of all types should not be used to pierce the sealing compound. In general, VCSEL should only be handled at the housing. This also applies to VCSEL without a diffuser, since the surface can also become scratched.

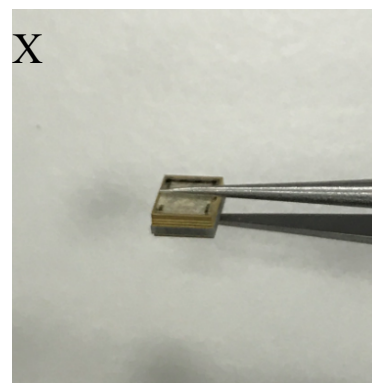
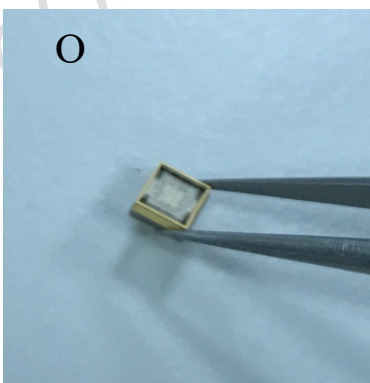

4. Soldering Condition

- 4.1 Pb-free solder temperature profile
(JEDEC-STD-020 latest version compliant)

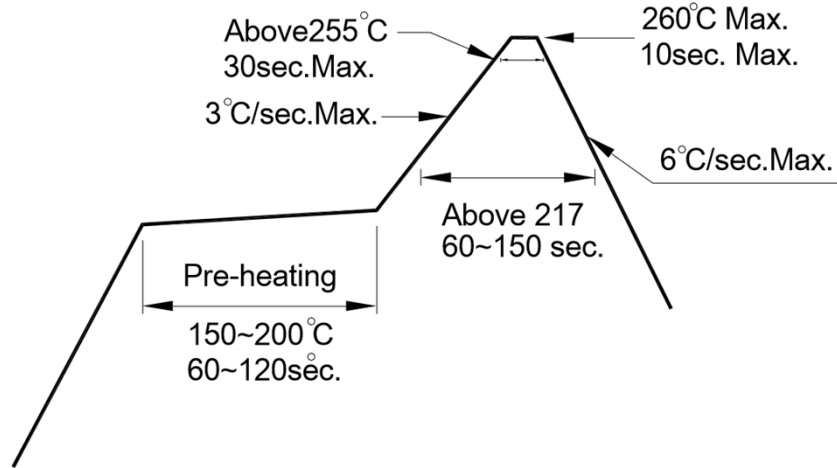

- 4.2 Reflow soldering should not be done more than two times.
4.3 When soldering, do not put stress on the VCSEL during heating.
4.4 After soldering, do not warp the circuit board.

5. Soldering Iron

- 5.1 Each terminal is to go to the tip of soldering iron temperature less than 350°C for 3 seconds within once in less than the soldering iron capacity 25W. Leave two seconds and more intervals, and do soldering of each terminal. Be careful because the damage of the product is often started at the time of the hand solder.

6. Repairing

- 6.1 Repair should not be done after the VCSEL have been soldered. When repairing is unavoidable, a double-head soldering iron should be used (as below figure). It should be confirmed beforehand whether the characteristics of the VCSEL will or will not be damaged by repairing.



Carrier Taping

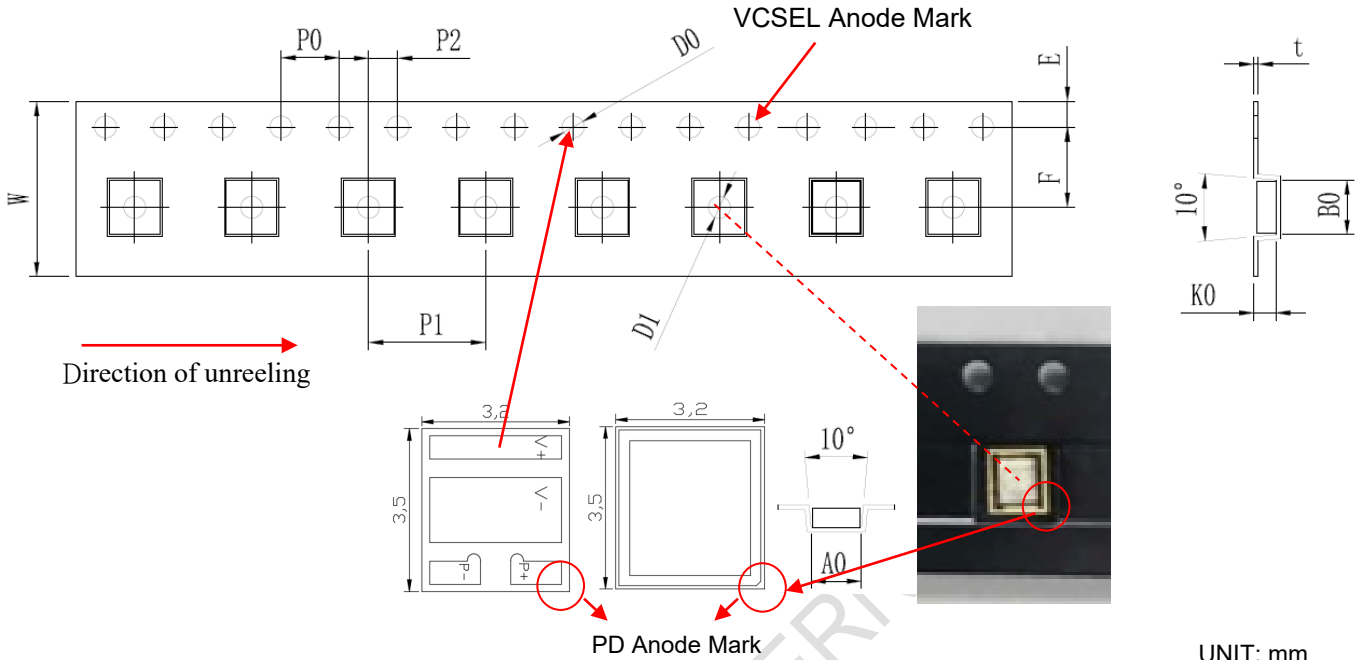

UNIT: mm

symbol	Ao	Bo	Ko	Po	P1	P2	T
spec	3.45±0.10	3.75±0.10	1.50±0.10	4.00±0.10	8.00±0.10	2.00±0.10	0.30±0.05
symbol	E	F	Do	D1	W	10Po	--
spec	1.75±0.10	5.50±0.10	1.50+0.10-0.0	1.50±0.10-0.0	12.00±0.30	40.0±0.10	--

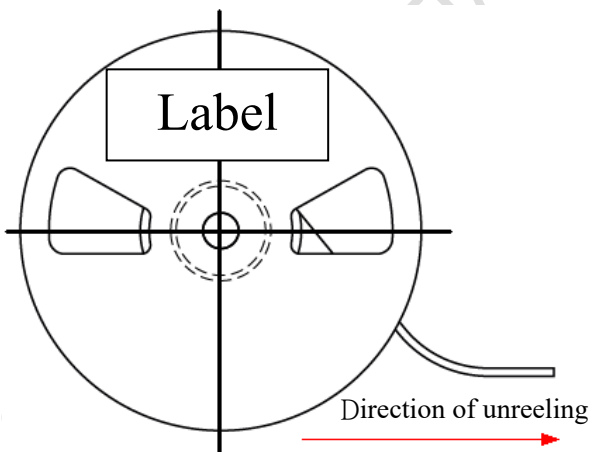

7-inch Anti-Static Reel
Max 500pcs/reel



Product Labeling



- P/N: OCS Product Model Name
- LOT: Lot Number
- QTY: Q'ty
- BIN: mW/nm/Vf (ex.[A1/94/V1])
- DATE: Enter the warehouse

Moisture Resistant Packing

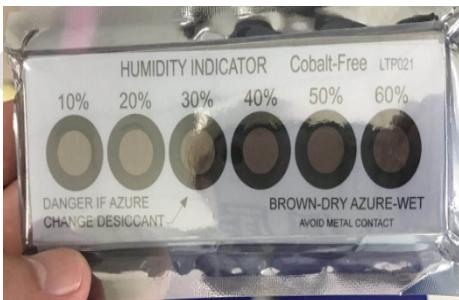
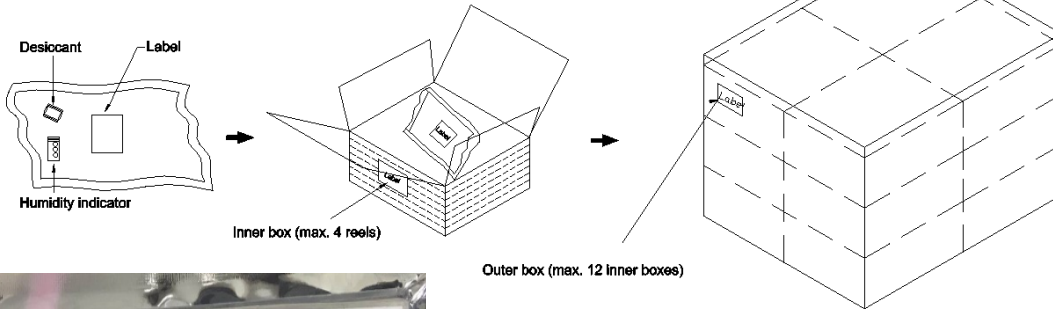
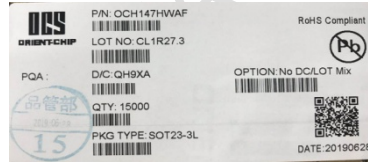
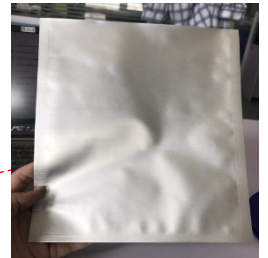
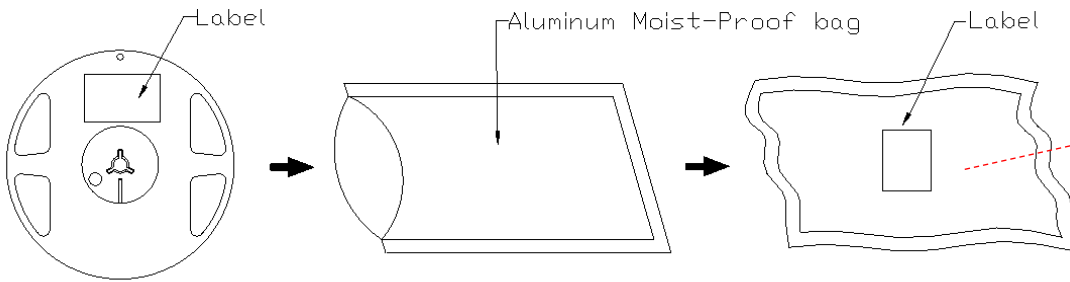



■ **Modified records**

Version	Description	Issue Date
V0	New spec	2019/03/20
V1	Add lth, Slope	2019/10/05
V2	Update spec	2019/10/14

OCS CONFIDENTIAL INTERNAL USE ONLY